

PEDESTRIAN PALLET TRUCK

PLL 180

Flexible use in small stores, food branches and "Do-it-yourself-shops" by compact construction. High side- and drive stability with 4-point-chassis.

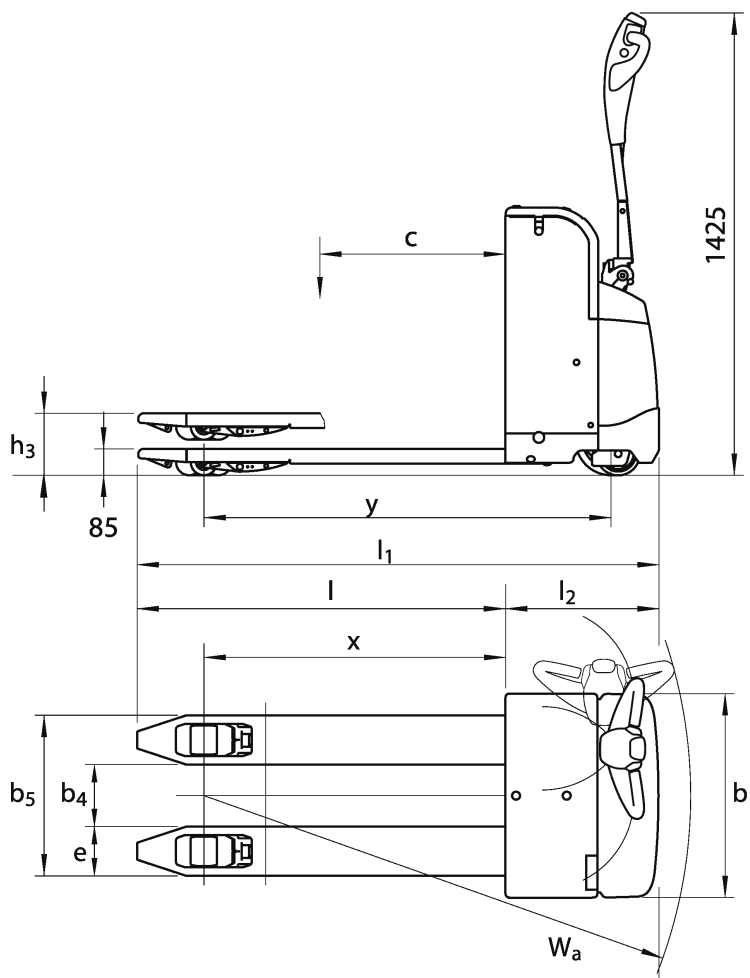

Mast type	Lift height H	Height of mast lowered h1	Max mast height h4
Standard/Duplex			
Triplex			

Distinguishing mark	0	Specification		PLL 180	
	1.2	Manufacturer's type designation			
	1.3	Drive: electric (battery or mains), diesel, petrol, fuel gas		Electric	
	1.4	Operator type: hand, pedestrian, standing, seated, order-picker		Pedestrian	
	1.5	Load capacity/rated load	Q	t	1.8
	1.6	Load centre distance	c	mm	600
	1.8	Load distance, centre of load axle to fork	X		722 / 912
	1.9	Wheelbase	y	mm	1135 / 1325
	Weight	2.1	Service weight incl battery		kg
2.2		Axle load, with load, front/rear		kg	
2.3		Axle load, without load, front / rear		kg	900 / 1400
2.4		Axle load, fork outreached with load, front / rear		kg	395 / 105
2.5		Axle load, fork retracted with load, front / rear		kg	
Tyres, chassis	3.1	Tyres			Vulcollan
	3.2	Tyre size, drive side		mm	Ø 230x70
	3.3	Tyre size, load side		mm	Ø 85x99
	3.4	Dimensions additional wheels (castor wheels)		mm	Ø 140x60
	3.5	Wheels, number front/rear (drive side/load side, x = driven wheels)			1x 1/2
	3.6	Track, drive side	b10	mm	382
	3.7	Track, load side	b11	mm	360
Dimensions	4.1	Tilt of mast/fork carriage, forward/backward		Grad	
	4.2	Height, mast lowered	h1	mm	
	4.3	Free lift	h2	mm	
	4.4	Lift height H = h13+h3	H	mm	205
	4.5	Height, mast extended	h4	mm	
	4.6	Straddle lift	h5	mm	
	4.7	Height of overhead guard (cabin)	h6	mm	
	4.8	Seat height/stand height	h7	mm	
	4.10	Height of wheel arms	h8	mm	
	4.11	Additional lift	h9	mm	
	4.14	Stand height, elevated	h12	mm	
	4.15	Height lowered	h13	mm	85
	4.19	Overall length	l1	mm	1505 / 1695
	4.20	Length to face of forks	l2	mm	505
	4.21	Overall width	b1	mm	660
	4.21.1	Width over stabilizers		mm	
	4.22	Fork dimensions	s/e/l	mm	48 / 160 / 1190
	4.23	Fork carriage to ISO 2328, clas / form A, B			
	4.24	Width of fork carriage	b3	mm	
	4.25	Width over forks, min/max	b5	mm	520 / 680
	4.26	Distance between wheel arms	b4	mm	
	4.27	Width across guide rolls	b6	mm	
	4.28	Reach distance	l4	mm	
	4.29	Reach lateral	b7	mm	
	4.30	Reach lateral from vehicle centerline	b8	mm	
	4.31	Ground clearance, mast	m1	mm	
	4.32	Ground clearance, centre of wheelbase	m2	mm	37 - 150
	4.33	Aisle width with pallet 1000 x 1200, crosswise	Ast	mm	
	4.34	Aisle width for pallet 800 x 1200, lengthwise	Ast	mm	2113
		Transfer aisle	0	mm	
	4.35	Turning radius	Wa	mm	1435 / 1625
	4.37	Length incl reach legs	l7	mm	
4.38	Distance to swivelling-fork pivot	0	mm		
Performance data	5.1	Travel speed, with/without load		km/h	5,7 / 6,0
	5.1.1	Travel speed with/without load, backwards		km/h	
	5.2	Lift speed, with/without load		m/s	
	5.3	Lowering speed, with/without load		m/s	
	5.4	Reach speed, with / without load		m/s	
	5.7	Gradient, with/without load		%	6 / 19
	5.8	Max gradeability, with / without load, 5 min rating		%	
	5.9	Acceleration time 0-10 m, with/without load		s	8,14 / 6,76
	5.10	Service brake: electric, hydraulic			Electric
	5.10.1	Parking brake: electric, hydraulic			Electric
Electric engine	6.1	Drive motor, rating S2 60 min		kW	1,3 AC
	6.2	Lift motor		kW	2,2
	6.3	Battery according to DIN 43531/35/36	A,B,C		
	6.4	Battery voltage / Battery capacity		V/Ah	24 / 150-230
	6.5	Battery weight		kg	140 - 215*
	6.6	Power consumption according to VDI cycle		kWh/h	
Additional data	8.1	Speed regulation			AC
	10.1	Operating pressure attachments		bar	
	10.2	Oil flow for attachments		l/min	
	10.7	Noise level at operator's ear, according to EN 12 053		db(A)	

* Varies according to battery size